

OG-C10DA

1x9 Analog Video Distribution Amplifier

openGear Card

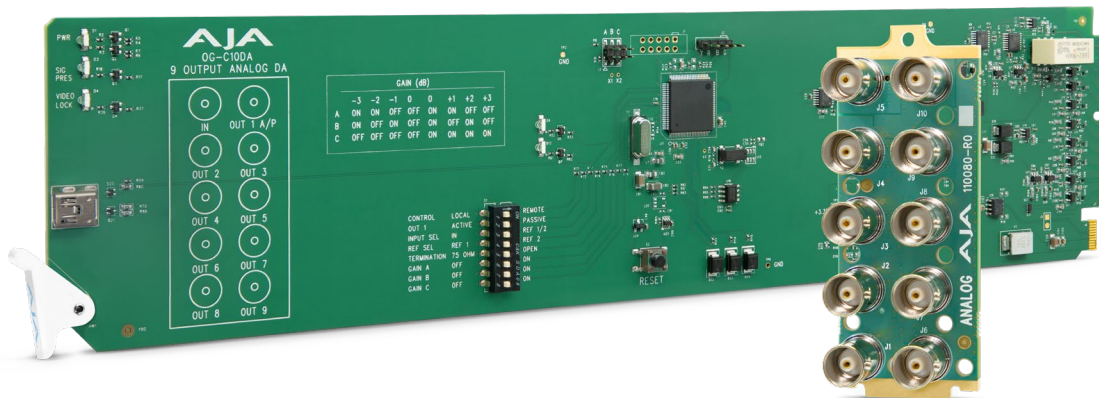

Installation and Operation Guide

Version 1.0r1
Published September 3, 2024



Notices

Trademarks

AJA® and Because it matters.® are registered trademarks of AJA Video Systems, Inc. for use with most AJA products. AJA™ is a trademark of AJA Video Systems, Inc. for use with recorder, router, software and camera products. Because it matters.™ is a trademark of AJA Video Systems, Inc. for use with camera products.

Corvid Ultra®, Io®, Ki Pro®, KONA®, KUMO®, ROI® and T-Tap® are registered trademarks of AJA Video Systems, Inc.

AJA Control Room™, KiStor™, Science of the Beautiful™, TruScale™, V2Analog™ and V2Digital™ are trademarks of AJA Video Systems, Inc.

All other trademarks are the property of their respective owners.

Copyright

Copyright © 2024 AJA Video Systems, Inc. All rights reserved. All information in this manual is subject to change without notice. No part of the document may be reproduced or transmitted in any form, or by any means, electronic or mechanical, including photocopying or recording, without the express written permission of AJA Video Systems, Inc.

Contacting AJA Technical Support or Sales

Please have all pertinent information at hand prior to contacting AJA support or sales.

Support Telephone: +1.530.271.3190

Support Website: <https://www.aja.com/support/contact>

Support Email: support@aja.com

Sales Email: sales@aja.com

Shipping Address: AJA Video Systems
180 Litton Drive
Grass Valley, CA 95945, USA

Contents

Notices	2
Trademarks	2
Copyright	2
Contacting AJA Technical Support or Sales	2
Chapter 1 – Introduction	4
Overview	4
Features	4
Block Diagram	5
I/O Connections	5
User Controls	5
DIP Switches	5
Signal Indicators in the DashBoard Control System	6
User Controls	8
DashBoard Control System	8
openGear and AJA	8
Installation	8
Summary	8
Unpacking	8
OG-C10DA Rear Card Installation	9
OG-C10DA Front Card Installation	10
Cabling	11
Chapter 2 – Operation	12
Default Operational Settings	12
DIP Switch Settings	12
Using the DashBoard Control System	13
Requirements	13
Control Interface Basic Components	13
Basic Tree View of Frames and Cards	14
Card Information and Status	14
Parameter Controls	16
Config Tab Screen	17
Setup Tab Screen	18
Uploading New Software	18
To Upload New Software	18
Rebooting	20
To Reboot the OG-C10DA	21
Appendix A – Specifications	22
OG-C10DA Tech Specs	22
Appendix B – Safety and Compliance	24
5 Year Warranty and Liability Information	33
AJA Software License Agreement	34
Index	37

Chapter 1 – Introduction

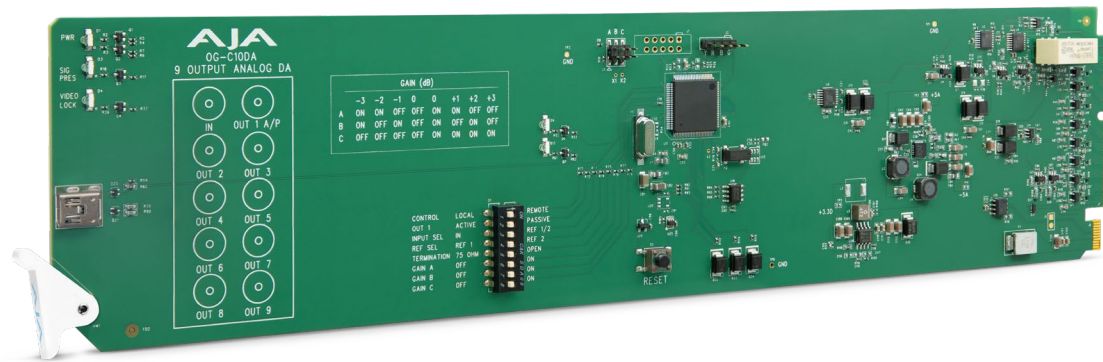

Overview

AJA's openGear compatible OG-C10DA is a 1x9 analog distribution amplifier (with loop out option) used to distribute NTSC and PAL analog video, bi-level video reference, and tri-level video reference signals and can also be used to distribute other single ended signals such as AES3-id digital unbalanced audio, and LTC signal type distribution. The OG-C10DA offers the ability to distribute multiple copies of the incoming signal or extend the composite video content with gain adjustment to compensate for long cable runs where needed.

Designed for use in high density openGear 2RU frames including AJA's OG-X-FR frame, new DashBoard Software support on Windows®, macOS® and Linux® offers remote control and monitoring of the openGear architecture and provides convenient and industry-standard configuration, monitoring and control options over a PC or local network.

Features

- 1x9 analog distribution amplifier, (1x loop out option)
- Supports analog NTSC, PAL, black-burst or tri-level sync
- AES3-id (digital unbalanced audio) and LTC supported
- Selectable input - external BNC, frame input Ref 1 or frame input Ref 2
- Monitor and control via Ross DashBoard software
- DIP switches for local control (Loop, Ref In, Termination, and Gain)
- Input Present LED
- Remote Ethernet configuration through Ross DashBoard software
- Power: 6.75 watts max per card
- Hot swappable
- Compatible with OG-X-FR, OG-3-FR, and DFR-8321 openGear frames
- Five year warranty

Block Diagram

Figure 1. OG-C10DA Converter, Simplified Block Diagram

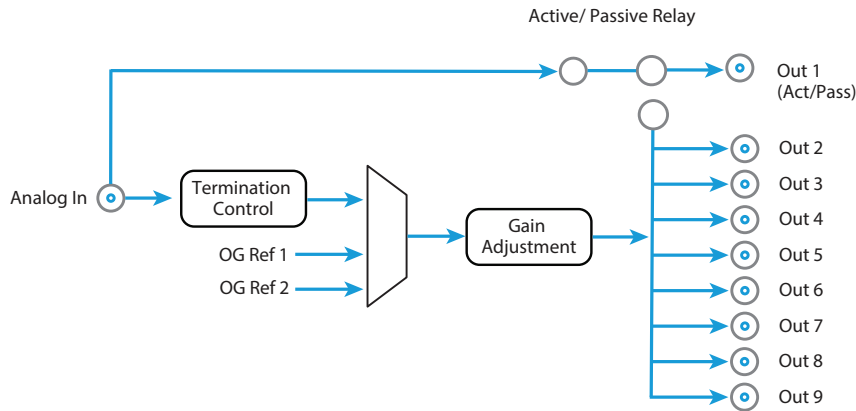

I/O Connections

Figure 2. OG-C10DA Converter Connections

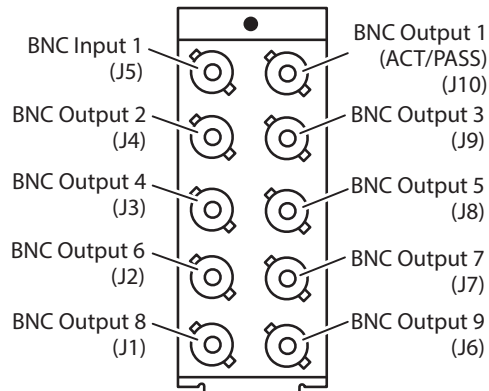

User Controls

User Control options for the OG-C10DA consist of DIP switches on the card and the DashBoard Control System from Ross Video. Both options are described below.

DIP Switches

The OG-C10DA has an 8 position DIP switch accessible on the card. The DIP switches can be used to configure the unit's Input, Loop Out, Termination, and Gain settings. When using DIP switches for control, DashBoard displays only the Card and Status tabs and cannot be used for configuration.

Figure 3. OG-C10DA DIP Switches

CONTROL	LOCAL	REMOTE
OUT 1	ACTIVE	PASSIVE

INPUT SEL	IN	REF 1/2
REF SEL	REF 1	REF 2
TERMINATION	75 OHM	OPEN
GAIN A	OFF	ON
GAIN B	OFF	ON
GAIN C	OFF	ON

Functions of the DIP switches are described in "[DIP Switch Settings](#)" on page 12.

Signal Indicators in the DashBoard Control System

Card Alarm State – Red

This potential card state will result in a red alarm indicator:

- HW Status Unsupported Rear Module

Figure 4. Card Alarm State Red

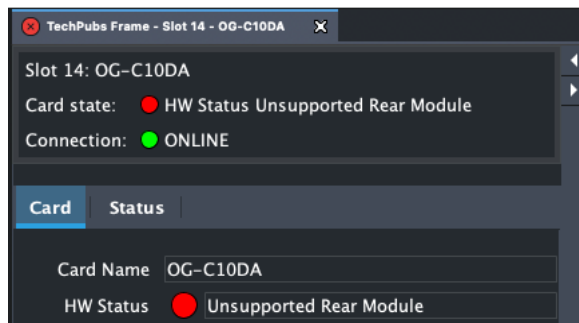

IMPORTANT: A common reason for this error message to occur is that the card has not been fully inserted. When inserting the card, there will be an initial click and it may seem like the card is fully inserted. However, you need to push the card into the frame a little bit harder until you hear or feel a second click.

Card Alarm State – Yellow

When the signal is either not present or is not locked, the DashBoard Control System shows a yellow Card State alarm: "Signal Status - No Signal" or "Signal Status - No Lock".

The yellow Card State alarm will also be set if the DIP switch configuration is set for local control.

Figure 5. Signal not present or not locked

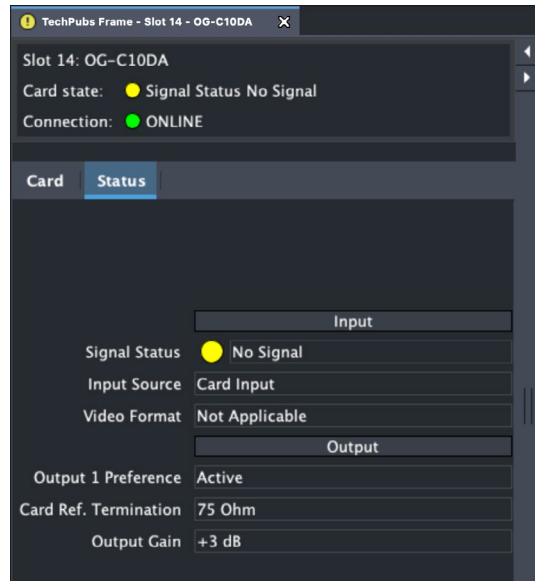

Green Card State Alarm

When there is a valid input signal detected, the DashBoard Control System shows a green Card State. Additionally, under the Input status, the Signal Status will indicate that a signal is detected along with type of video detected if applicable.

A green Card State will only be set if the card is set to remote control and there is a signal detected.

Figure 6. Signal is present and locked

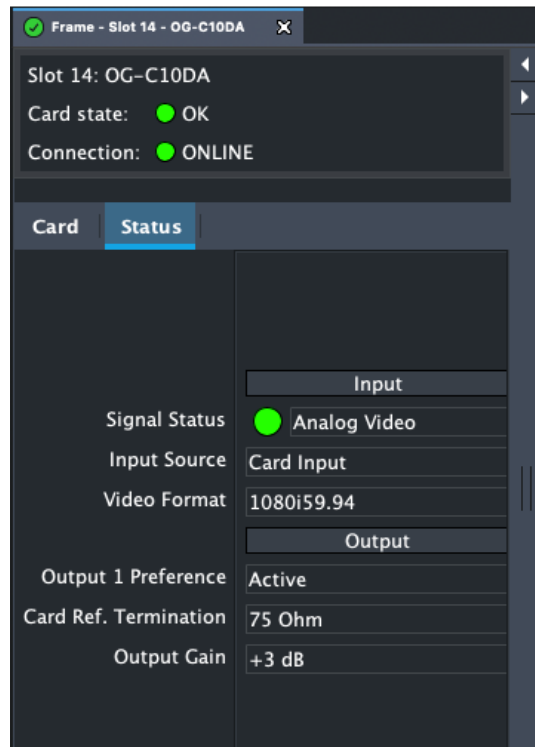

User Controls

The OG-C10DA can be used right out of the box for many applications, since it is designed to recognize inputs and perform standard actions automatically. However, you can also manually configure the OG-C10DA using remote configuration through the DashBoard Control System for an openGear Frame.

DashBoard Control System

The DashBoard Control System, created by Ross Video, provides a control interface between Windows, macOS and Linux computers and the cards installed in an openGear frame. DashBoard operates through TCP/IP communication and requires an Ethernet connection between the controlling computer and an openGear frame.

For details about acquiring and using the DashBoard Control System, refer to ["Default Operational Settings" on page 12.](#)

openGear and AJA

openGear is an open-architecture, modular frame system designed by Ross Video and supported by a diverse range of terminal equipment manufacturers, including AJA. Ross Video manufactures the frames, power supplies and network cards for openGear. AJA is a reseller of the openGear frames.

AJA Video is a leading manufacturer of video interface technologies, converters, digital video recording solutions and professional cameras, bringing high-quality, cost-effective products to the professional, broadcast and post-production markets. AJA products, including openGear cards, are designed and manufactured at our facilities in Grass Valley, California.

Installation

Summary

Installing an OG-C10DA card into an OG-X-FR openGear frame consists of the following steps:

- Install the rear card onto the back of the frame corresponding to the slot pair you will be using for the OG-C10DA card.
- Insert the OG-C10DA card into the frame in the right (even numbered) slot of the pair.
- Connect the BNC cabling to the rear card.



ESD Susceptibility - Static discharge can cause serious damage to sensitive semiconductor devices. Avoid handling circuit boards in high static environments such as carpeted areas, and when wearing synthetic fiber clothing. Always exercise proper grounding precautions when working on circuit boards and related equipment.

Unpacking

Unpack each openGear product you received from the shipping container and ensure that all items are included. If any items are missing or damaged, contact your sales representative or AJA directly.

Parts List

Quantity	Description
1	OG-C10DA Front Card in ESD bag
1	Analog 10 BNC Rear Card in ESD bag

OG-C10DA Rear Card Installation

1. Ensure that the frame is properly installed.
2. Locate the card frame slot on the rear of the openGear frame into which you wish to install the openGear card.

NOTE: An OG-C10DA card occupies two slots in the frame.

3. Using a Phillips screwdriver, unscrew the top screw from the desired blank plate and remove the blank plate.
4. Seat the bottom of the rear card in the seating slot at the base of the frame backplane.

Figure 7. Rear Card Inserting into Frame Seating Slot

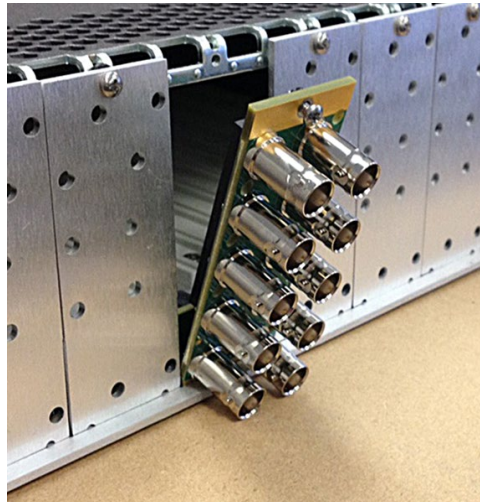

5. Align the top screw of the rear card with the screw hole on the top edge of the frame backplane.
6. Ensure the rear card aligns with the desired card slot before tightening the screw.
7. Using a Phillips screwdriver, fasten the rear card to the frame backplane. Do not over tighten.

Figure 8. Rear Card Inserted into Frame Seating Slot

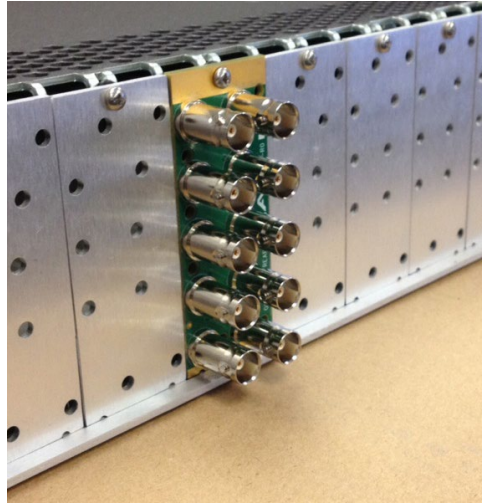

8. Ensure proper frame cooling and ventilation by having all rear frame slots covered with rear cards or blank plates if plates are not pre-installed.

OG-C10DA Front Card Installation

1. Open the openGear frame door as follows:
 - A. Gently pull the side door tabs towards the center of the door, releasing the door from the frame.
 - B. Using both hands, pull the door towards you. The door extender arms prevent the door from falling.
2. Locate the rear card you installed as described above. The interior slot number is dependent on the slot combinations into which you installed the rear card. This allows adequate spacing to avoid damaging the card, the cards installed in the neighboring slots, or both.
3. Hold the card by the edges and carefully align the card edges with the rails inside the frame. The slots are numbered starting from the left-most slot when facing the frame front.

IMPORTANT: OG-C10DA cards are installed into the right (even numbered) slot of the pair in order to connect with the rear panel.

4. Fully insert the card into the frame until the card is properly seated in the rear card. There are two stages to inserting the card:
 - A. After you feel the card's first click, its position in the frame will resemble the photograph below in [Figure 9](#).
 - B. Next, press against the white plastic tab again until you feel the second click. The card's position will resemble the photograph below in [Figure 9](#).

NOTE: Some cards require more pressure than others to be fully inserted. Make sure that the plastic tab at the bottom of the front edge of the card is completely upright. If it is tilting forward, the card is not yet fully inserted.

Figure 9. Partially Inserted (Left) versus Fully Inserted (Right) Front Card



NOTE: Observe the position of the white locking tab and presence of LED indicators in fully inserted card.

5. Close the frame door as follows:
 - A. Slide the door into the frame.
 - B. Pull and release the door tabs to ensure the frame door is securely locked to the frame.

Cabling

Refer to ["I/O Connections" on page 5](#) to identify the input and output signal connectors.

Chapter 2 – Operation

Default Operational Settings

The OG-C10DA converter ships from the factory with the following configuration:

- Local (DIP switch) control (DashBoard shows status only).

If these settings apply to your requirements, you can simply connect the video input and output signal cables.

For other applications, you can configure the card using its DIP switch settings, or by setting Remote (DIP switch) control and using the DashBoard Control System and a PC or Mac networked to an openGear frame.

DIP Switch Settings

DIP switch settings can be used to configure the functions of the OG-C10DA card. See the following tables for detailed descriptions of the DIP switch settings. Use DIP Switches 6, 7, and 8 in combination to specify Gain dB values (see [Table 2](#)).

Table 1. Description of the DIP Switch Settings

SWITCH	FUNCTION	LABEL	LABEL	BEHAVIOR
1	Control	Local	Remote	When set to Local, the card can be controlled only through the DIP switches, although DashBoard will display status. When set to Remote, the card can be controlled only through the DashBoard Control System.
2*	OUT 1	ACTIVE	PASSIVE	When set to Active, BNC Output 1 will follow the same parameters that BNC Outputs 2-9 have been set to. When set to Passive, it will behave as loop out and will still pass signal even if the main card or frame were to lose power. * Passive loop out only follows BNC IN input. Active follows selected input.
3	INPUT SEL	IN	REF 1/2	When set to In, BNC Input 1 will be used as the input source. When set to REF 1/2, REF 1 or REF 2 will be used as the input source.
4	REF SEL	REF 1	REF 2	When set to REF 1, the REF 1 Input on the OG Frame will be used as the input source. When set to REF 2, the REF 2 Input on the OG Frame will be used as the input source. Switch 3 (INPUT SEL) must be set to REF 1/2 for either of the settings to be active.
5**	TERMINATION	75 OHM	OPEN	When set to 75 OHM, the BNC IN input is 75 OHM terminated at the device. When set to OPEN, the termination is left open. **When set to passive loop out, OUT 1 can terminate the input signal if connected to another downstream device with termination. This can cause issues if you are also terminating on the OG-C10DA (double termination).
6	GAIN A	OFF	ON	Switch settings 6, 7, and 8 are combined to determine the output gain (-3 to +3 db). See Table 2
7	GAIN B	OFF	ON	
8	GAIN C	OFF	ON	

Table 2. Combination of Gain dB DIP Switch Settings

SWITCH	FUNCTION	Gain (dB) SETTING							
		-3	-2	-1	0	0	+1	+2	+3
6	GAIN A	ON	ON	OFF	OFF	ON	ON	OFF	OFF
7	GAIN B	ON	OFF	ON	OFF	ON	OFF	ON	OFF
8	GAIN C	OFF	OFF	OFF	OFF	ON	ON	ON	ON

Using the DashBoard Control System

The DashBoard Control System is available as a free download from the openGear DashBoard Software Download webpage:

<https://www.opengear.tv/frame-and-control/control-system/download/>

Ross Video offers comprehensive documentation that covers the extensive capabilities of the DashBoard Control System:

<https://www.rossvideo.com/support/product-documentation/dashboard/>

This AJA OG-C10DA manual addresses only those essential aspects of the DashBoard Control System needed to control the OG-C10DA card.

Requirements

The DashBoard Control System requires the following components:

- openGear frame with a Frame Controller card
- Ethernet connection between the controlling computer and the openGear frame

NOTE: The openGear frame ships from AJA with the MFC-8322-S Frame Controller card for controlling the new AJA DashBoard cards. The openGear frame also supports the MFC-OGX-N Advanced Networking Frame Controller card, which can be used to control compatible OG cards.

DashBoard automatically discovers openGear and DashBoard Connect devices, such as openGear frames and cards that are present and accessible on your network.

Control Interface Basic Components

The basic components of the DashBoard Control System user interface consist of the basic tree view of frames and cards, the card information and status panel, and the parameter controls panel. These elements are shown below in [Figure 10](#).

The basic tree view of frames and cards shows the frames and cards that are discoverable by DashBoard on your network.

The card information and status panel, shown in the middle panel, display the basic status of the card currently selected in DashBoard.

The parameter controls panel shows the tabs and parameters that the selected card has available for configuration and control.

Figure 10. Main Sections of the DashBoard User Interface

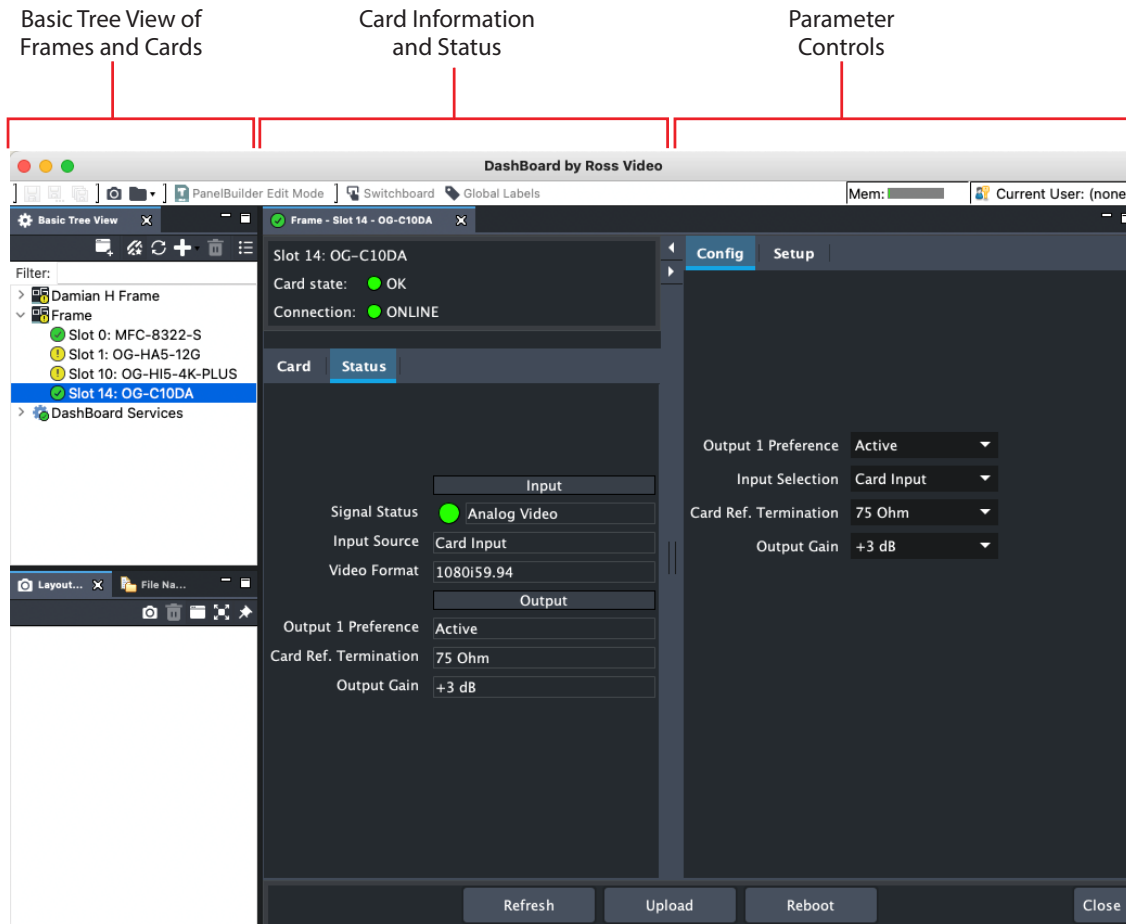

Basic Tree View of Frames and Cards

The basic tree view in the left column shows the frames and cards that are discoverable by DashBoard on your network.

Card Information and Status

The card information and status panel, shown in the middle panel, display the basic status of the card currently selected in DashBoard. The fields in this panel indicate that they are read-only.

Card Tab Screen

Figure 11. OG-C10DA Card Tab Screen in Dashboard

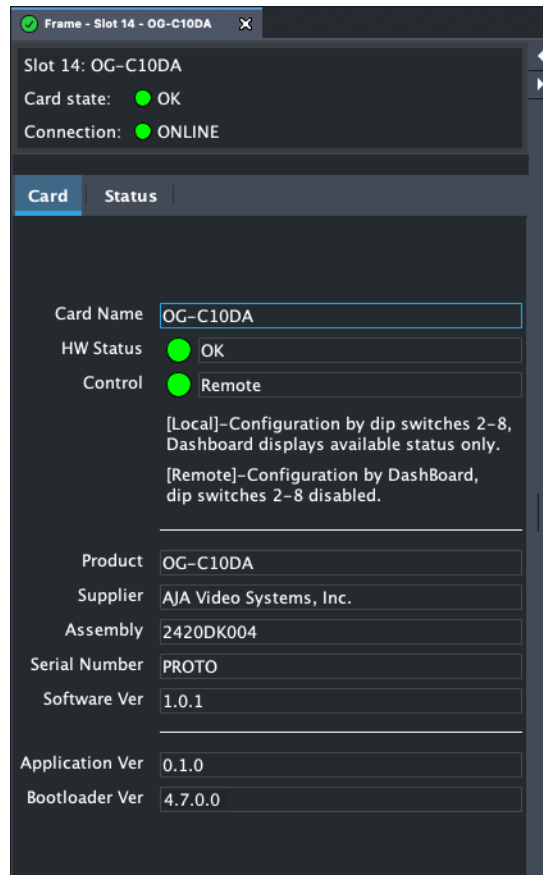

The Card information screen indicates the basic information about the card itself such as the card name, hardware status, serial number, software version and other items.

Card Name

This field reports that OG card's name, which you can define with the Setup Tab Screen.

Assembly -

This is the factory assembly number.

Serial Number

This is the factory set unique serial number of your OG card. If you ever call AJA Support for service, you may be asked for this number.

Software Ver

This shows the currently installed firmware for that OG card.

Status Tab Screen

Figure 12. OG-C10DA Status Tab Screen in Dashboard

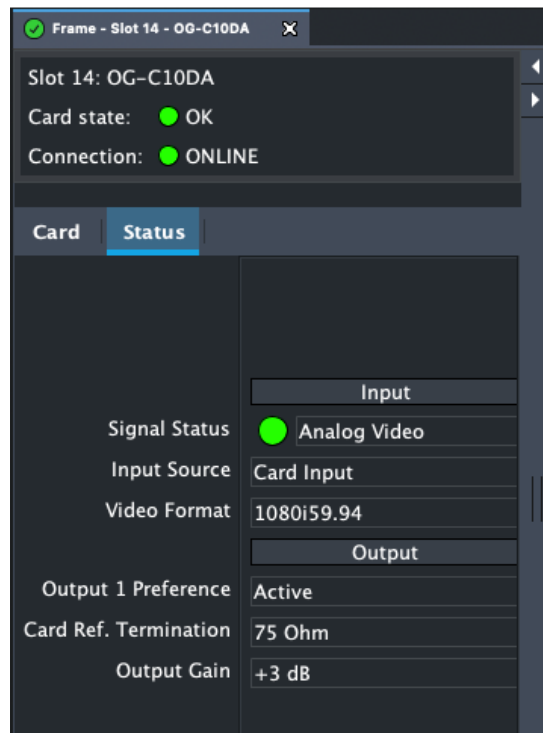

The Status tab provides detailed information on the current input and output signal status for the card. See "[Config Tab Screen](#)" on page 17.

Input

Signal Status - No Signal, Analog Video, Signal Detected - LTC, Signal Detected

NOTE: AES3-id and/or LTC Audio will be detected but "Not Applicable" will be displayed under the Video Format section.

Input Source - Card Input, OG Frame Ref 1, or OG Frame Ref 2

Video Format - Framerate and Raster information. For example: 1080i59.94.

Output

Output 1 Preference - Options are Active or Passive.

Card Ref. Termination - Options are 75 Ohm or Open.

Output Gain - Options (in dB) are -3,-2,-1,0,+1,+2,+3.

Parameter Controls

The parameter controls panel on the right side of Dashboard shows the tabs and parameters that are configurable for the OG-C10DA. These fields can be written to or modified.

Config Tab Screen

Figure 13. OG-C10DA Config Tab Screen in Dashboard

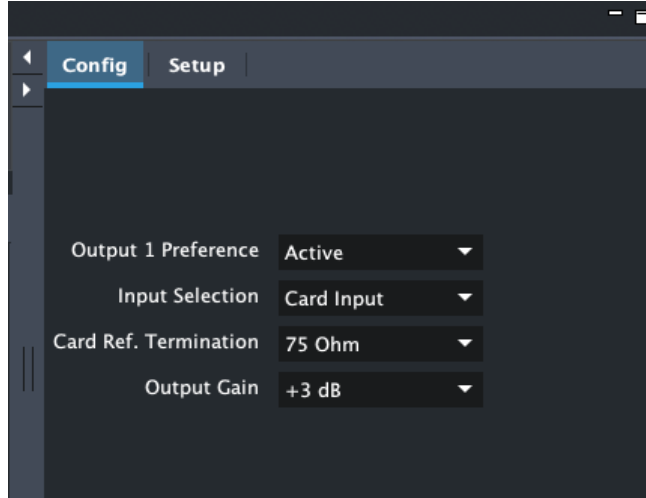

Output 1 Preference

Select Output mode preference. Options are :

- Active
- Passive

Input Selection

Select Input type. Options are :

- Card Input
- OG Frame Ref 1
- OG Frame Ref 2

Card Ref. Termination

Select Termination type. Options are :

- 75 Ohm
- Open

Output Gain

Select Output Gain level in dB. Options are :

- -3
- -2
- -1
- 0
- +1
- +2
- +3

Setup Tab Screen

Click on the Setup tab to view and make changes to the card name or to restore card settings to factory default values.

Figure 14. OG-C10DA Setup Tab Screen in DashBoard

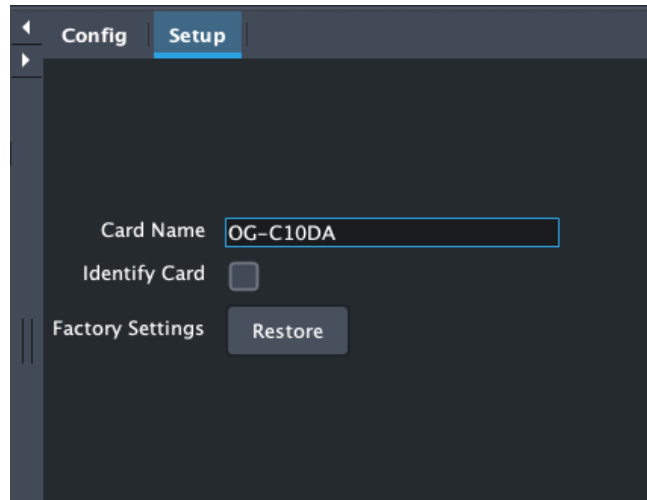

Click on the Setup tab to view and make changes to the card name, to identify the card in the openGear frame, or to restore card settings to factory default values.

Card Name - By default, this field is pre-populated with the card name OG-C10DA. You can change the card name by editing the text in the Card Name field.

NOTE: Changing the Card Name in the Setup tab also changes the name of the card in the DashBoard tree view.

Identify Card - Select the checkbox to turn on the Identify Card function. When this function is turned on, an LED light on the front of the OG-C10DA card inside the openGear frame will blink to help you quickly identify the card. Open the front of the openGear frame in order to see the light blinking.

Factory Settings - If you would like to revert the card settings to factory default values, click **Restore**. A confirmation prompt displays. Select "Yes" to restore factory settings. Select "No" to cancel.

Uploading New Software

When available, you can upload updated software to the OG-C10DA through the DashBoard Control System by following the steps below.

To Upload New Software

1. Check the AJA website for new software for your OG-C10DA. If new software is found, download it and uncompress the file archive (zip).
2. Click the Upload button in the lower panel of the DashBoard Control System to open the Upload Software Wizard.

Figure 15. OG-C10DA Upload Software Wizard window in DashBoard

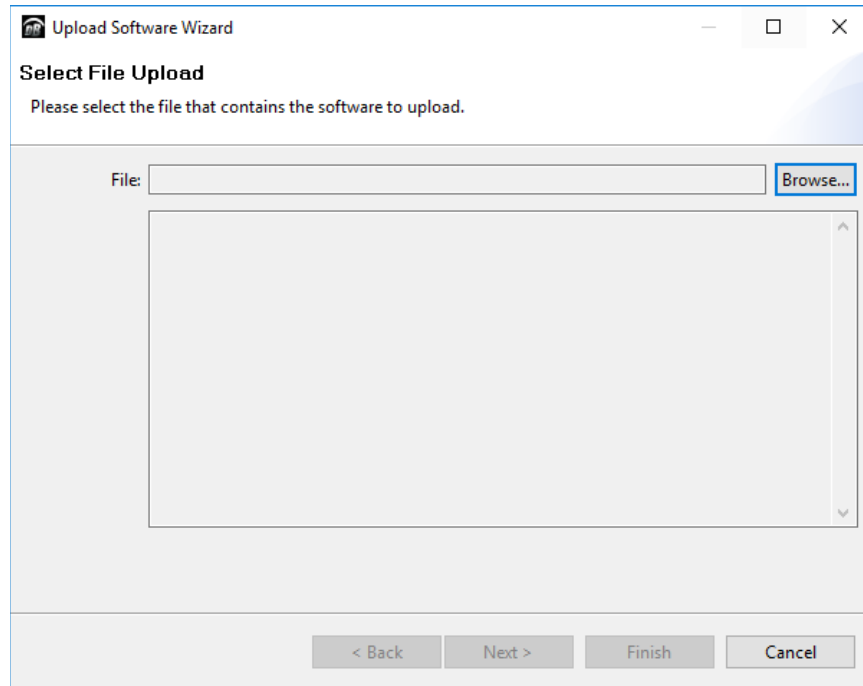

3. From the Upload Software Wizard window, select **Browse**.
4. Navigate to the location of the downloaded .bin file containing the software update. Select the .bin file, then select **Open**. The Upload Software Wizard window displays characteristics of the selected file for uploading.
5. Click **Finish**.

NOTE: Before the upload begins, DashBoard will erase the firmware on the card, taking approximately 20 seconds.

Figure 16. Note the message "Erasing, please wait 20 seconds"

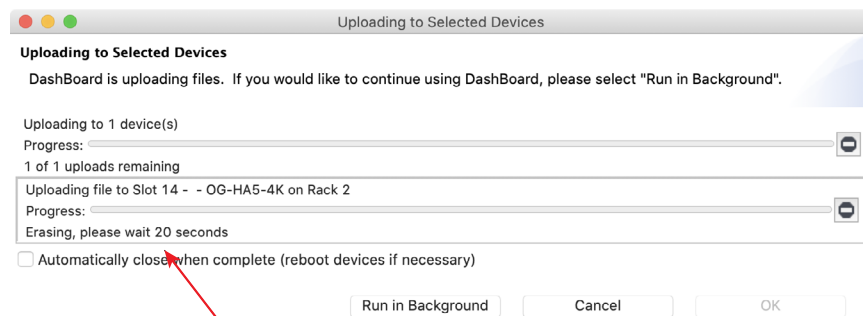

For the first 20 seconds,
DashBoard is erasing the
card's firmware.

After the erasing process has completed, the upload will begin, shown in the Uploading to Selected Devices window below.

Figure 17. OG-C10DA Uploading to Selected Devices window in DashBoard

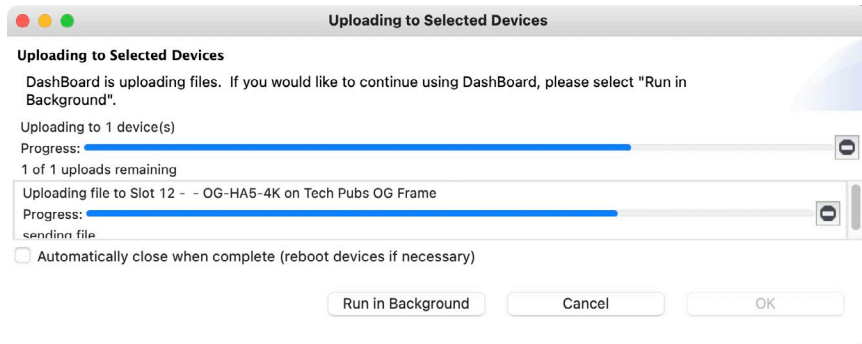

6. When the progress bar indicates that the uploading is finished and status indicates "Complete," click **OK**.
7. To verify the version of software or firmware currently installed on your card, select the Card tab from the center panel of DashBoard.

Figure 18. Dashboard Card Screen Showing Software Version

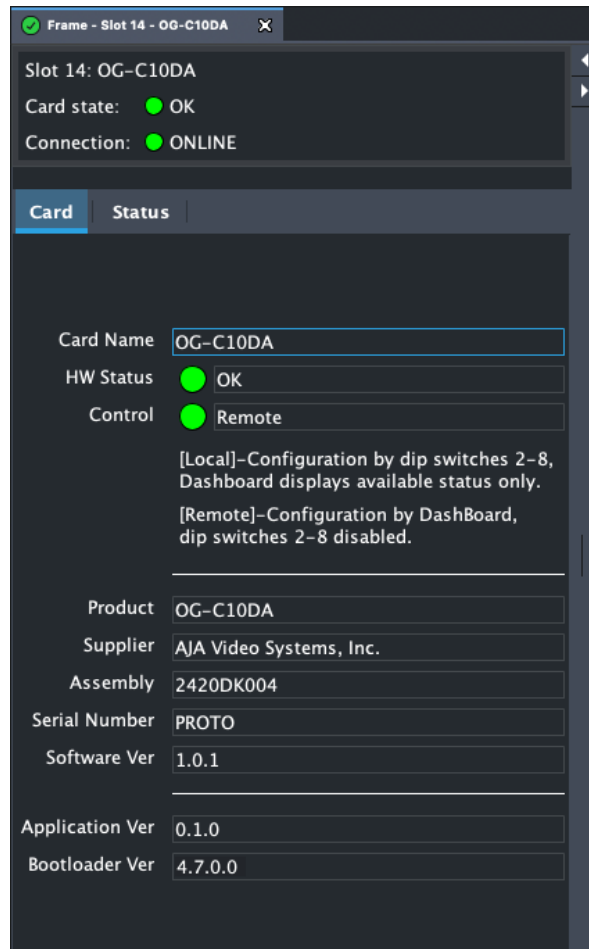

Rebooting

Rebooting is a standard function built in to the DashBoard Control System, and should only be performed if the board has become unresponsive.

WARNING: During a reboot, any card operations will be briefly interrupted, but will be restored once the reboot has completed.

To Reboot the OG-C10DA

1. Click the Reboot button in the lower panel of DashBoard. The reboot confirmation message displays.

Figure 19. Reboot confirmation window

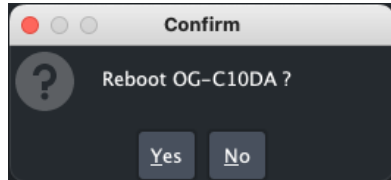

2. Click **Yes**. The message "Loading data, please wait. Refreshing device data" displays for a moment. The card will be offline for a few seconds, and any current operations will be interrupted.
3. Following a Reboot operation, the board configuration will return to the settings that were in place at the time of rebooting.

Appendix A – Specifications

OG-C10DA Tech Specs

Formats

- NTSC
- PAL
- Bi-level Reference
- Tri-level Reference
- AES3-id
- LTC

Inputs

- 1x BNC, Analog, Differential
- 2x openGear Frame Reference Inputs

Video Output Digital

- 1x BNC, Analog, Loop-out Active/Passive
- 8x BNC, Analog

Termination

- 75 Ohms or nonterminated

Video Bandwidth

- 0 – 6 MHz +/- 0.1dB

Gain

- -3dB, -2dB, -1dB, 0dB, +1dB, +2dB, or +3dB, +/- 0.3dB

Diff Gain

- 0.15%, not load dependent

Diff Phase

- 0.1 degree, not load dependent

H/V Tilt

- < 0.1%

Response Variation

- < 0.1dB 1 to 9 loads

Coupling

- DC

Max Common Mode Signal

- 8Vp-p

Return Loss

- > 15dB to 6 MHz all inputs and outputs

Output Isolation

- >40dB

User Interface

- openGear DashBoard network control software via Windows, macOS, or Linux
- Local/Remote Control
- Loop-out Control
- Input Selection
- Termination
- Gain

Size

- openGear standard form factor, front slot and rear card
- Two slots required for each card

Weight

- 0.5 lb (0.3 kg)

Power

- openGear frame compatible, 6.75 watts max per card

Environment

- Safe Operating Temperature Range: 0C to 40C (32F to 104F)
- Safe Storage Temperature Range (power OFF): -40C to 60C (-40F to 140F)
- Operating Relative Humidity: 10-90% noncondensing
- Operating Altitude: <3,000m (<10,000ft)

Appendix B – Safety and Compliance

Federal Communications Commission (FCC) Compliance Notices

Class A Interference Statement

This equipment has been tested and found to comply with the limits for a Class A digital device, pursuant to Part 15, Subpart B of the FCC Rules. These limits are designed to provide reasonable protection against harmful interference in a residential installation. This equipment generates, uses, and can radiate radio frequency energy and, if not installed and used in accordance with the instructions, may cause harmful interference to radio communications. However, there is no guarantee that interference will not occur in a particular installation. If this equipment does cause harmful interference to radio or television reception, which can be determined by turning the equipment off and on, the user is encouraged to try to correct the interference by one or more of the following measures:

- Reorient or relocate the receiving antenna.
- Increase the separation between the equipment and receiver.
- Connect the equipment into an outlet on a circuit different from that to which the receiver is connected.
- Consult the dealer or an experienced radio/TV technician for help.

FCC Caution

This device complies with Part 15 of the FCC Rules. Operation is subject to the following two conditions: (1) This device may not cause harmful interference, and (2) this device must accept any interference received, including interference that may cause undesired operation.

Canadian ICES Statement

Canadian Department of Communications Radio Interference Regulations

This digital apparatus does not exceed the Class A limits for radio-noise emissions from a digital apparatus as set out in the Radio Interference Regulations of the Canadian Department of Communications. This Class A digital apparatus complies with Canadian ICES-003.

Règlement sur le brouillage radioélectrique du ministère des Communications

Cet appareil numérique respecte les limites de bruits radioélectriques visant les appareils numériques de classe A prescrites dans le Règlement sur le brouillage radioélectrique du ministère des Communications du Canada. Cet appareil numérique de la Classe A est conforme à la norme NMB-003 du Canada.

European Union, European Free Trade Association (EFTA) and United Kingdom Regulatory Compliance

This equipment may be operated in the countries that comprise the member countries of the European Union, European Free Trade Association and the United Kingdom. These countries, listed in the following paragraph, are referred to as The European Community throughout this document:

AUSTRIA, BELGIUM, BULGARIA, CROATIA, CZECH REPUBLIC, DENMARK, ESTONIA, FINLAND, FRANCE, GERMANY, GREECE, HUNGARY, ICELAND, IRELAND, ITALY, LATVIA, LIECHTENSTEIN, LITHUANIA, LUXEMBOURG, MALTA, NETHERLANDS, NORWAY, POLAND, PORTUGAL, REPUBLIC OF CYPRUS, ROMANIA, SLOVAK REPUBLIC, SLOVENIA, SPAIN, SWEDEN, SWITZERLAND, UNITED KINGDOM

Declaration of Conformity

Marking by these symbols indicates compliance with the Essential Requirements of the EMC Directive of the European Union 2014/30/EU.



This equipment meets the following conformance standards::

Safety

EN 62368-1: 2014 + A11 (T-Mark License),
IEC 62368-1: 2014; (CB Scheme Certificate)

Additional licenses issued for specific countries available on request.

Emissions

EN 55032: 2012 + AC: 2013, CISPR 32: 2015, EN 61000-3-2: 2014, EN 61000-3-3: 2013

Immunity

EN 55103-2: 2009, EN 61000-4-2:2009, EN 61000-4-3: 2006 + A1:2008 + A2:2010,
EN 61000-4-4: 2012, EN 61000-4-5: 2014 + A1: 2017, EN 61000-4-6: 2013,
EN 61000-4-11: 2020

Environments: E2, E3 and E4

The product is also licensed for additional country specific standards as required for the International Marketplace.



Warning! This is a Class A product. In a domestic environment, this product may cause radio interference, in which case, the user may be required to take appropriate measures.

Achtung! Dieses ist ein Gerät der Funkstörgrenzwertklasse A. In Wohnbereichen können bei Betrieb dieses Gerätes Rundfunkstörungen auftreten, in welchen Fällen der Benutzer für entsprechende Gegenmaßnahmen verantwortlich ist.

Attention! Ceci est un produit de Classe A. Dans un environnement domestique, ce produit risque de créer des interférences radioélectriques, il appartiendra alors à l'utilisateur de prendre les mesures spécifiques appropriées.

Recycling Notice



This symbol on the product or its packaging indicates that this product must not be disposed of with your other household waste. Instead, it is your responsibility to dispose of your waste equipment by handing it over to a designated collection point for the recycling of waste electrical and electronic equipment. The separate collection and recycling of your waste equipment at the time of disposal will help conserve natural resources and ensure that it is recycled in a manner that protects human health and the environment. For more information about where you can drop off your waste for recycling, please contact your local authority, or where you purchased your product.

Korea KCC Compliance Statement

사용자안내문

이 기기는 업무용 환경에서 사용할 목적으로 적합성평가를 받은 기기로서 가정용 환경에서 사용하는 경우 전파간섭의 우려가 있습니다.

Taiwan Compliance Statement

警告使用者：
這是甲類的資訊產品，在居住的環境中使用時，可能會造成射頻干擾，在這種情況下，使用者會被要求採取某些適當的對策。

This is a Class A product based on the standard of the Bureau of Standards, Metrology and Inspection (BSMI) CNS 13438, Class A. In a domestic environment this product may cause radio interference in which case the user may be required to take adequate measures.

Japanese Compliance Statement

この装置は、クラスA情報技術装置です。この装置を家庭環境で使用すると電波妨害を引き起こすことがあります。この場合には使用者が適切な対策を講ずるよう要求されることがあります。 VCCI-A

This is a Class A product based on the standard of the VCCI Council (VCCI 32: 2016). If this equipment is used in a domestic environment, radio interference may occur, in which case, the user may be required to take corrective actions.

Translated Warning and Caution Messages

The following caution statements, warning conventions, and warning messages apply to this product and manual.



Warning Symbol



Hazard Symbol



Caution Symbol

Before Operation Please Read These Instructions



Warning! Read and follow all warning notices and instructions marked on the product or included in the documentation.

Avertissement! Lisez et conformez-vous à tous les avis et instructions d'avertissement indiqués sur le produit ou dans la documentation.

Warnung! Lesen und befolgen Sie die Warnhinweise und Anweisungen, die auf dem Produkt angebracht oder in der Dokumentation enthalten sind.

¡Advertencia! Lea y siga todas las instrucciones y advertencias marcadas en el producto o incluidas en la documentación.

Aviso! Leia e siga todos os avisos e instruções assinalados no produto ou incluídos na documentação.

Avviso! Leggere e seguire tutti gli avvisi e le istruzioni presenti sul prodotto o inclusi nella documentazione.



Warning! Do not use this device near water and clean only with a dry cloth.

Avertissement! N'utilisez pas cet appareil près de l'eau et nettoyez-le seulement avec un tissu sec.

Warnung! Das Gerät nicht in der Nähe von Wasser verwenden und nur mit einem trockenen Tuch säubern.

¡Advertencia! No utilice este dispositivo cerca del agua y límpielo solamente con un paño seco.

Aviso! Não utilize este dispositivo perto da água e limpe-o somente com um pano seco.

Avviso! Non utilizzare questo dispositivo vicino all'acqua e pulirlo soltanto con un panno asciutto.



Warning! Do not block any ventilation openings. Install in accordance with the manufacturer's instructions.

Avertissement! Ne bloquez aucune ouverture de ventilation. Suivez les instructions du fabricant lors de l'installation.

Warnung! Die Lüftungsöffnungen dürfen nicht blockiert werden. Nur gemäß den Anweisungen des Herstellers installieren.

¡Advertencia! No bloquee ninguna de las aberturas de la ventilación. Instale de acuerdo con las instrucciones del fabricante.

Aviso! Não obstrua nenhuma das aberturas de ventilação. Instale de acordo com as instruções do fabricante.

Avviso! Non ostruire le aperture di ventilazione. Installare in conformità con le istruzioni del fornitore.



Warning! Do not install near any heat sources such as radiators, heat registers, stoves, or other apparatus (including amplifiers) that produce heat.

Avertissement! N'installez pas l'appareil près d'une source de chaleur telle que des radiateurs, des bouches d'air de chauffage, des fourneaux ou d'autres appareils (amplificateurs compris) qui produisent de la chaleur.

Warnung! Nicht in der Nähe von Wärmequellen wie Heizkörpern, Heizregistern, Öfen oder anderen Wärme erzeugenden Geräten (einschließlich Verstärkern) aufstellen.

¡Advertencia! No instale cerca de fuentes de calor tales como radiadores, registros de calor, estufas u otros aparatos (incluidos amplificadores) que generan calor.

Aviso! Não instale perto de nenhuma fonte de calor tal como radiadores, saídas de calor, fogões ou outros aparelhos (incluindo amplificadores) que produzam calor.

Avviso! Non installare vicino a fonti di calore come termosifoni, diffusori di aria calda, stufe o altri apparecchi (amplificatori compresi) che emettono calore.



Warning! Do not defeat the safety purpose of the polarized or grounding-type plug. A polarized plug has two blades with one wider than the other. A grounding type plug has two blades and a third grounding prong. The wide blade or the third prong are provided for your safety. If the provided plug does not fit into your outlet, consult an electrician for replacement of the obsolete outlet.

Avertissement! La sécurité de la prise polarisée ou de la prise de type mise à la terre ne doit en aucun cas être empêchée de fonctionner. Une prise polarisée a deux broches, l'une étant plus large que l'autre. Une prise de type mise à la terre a deux broches et une troisième broche pour la mise à la terre. La broche large ou la troisième broche sont fournies pour votre sécurité. Si la prise fournie ne s'insère pas dans votre prise femelle, consultez un électricien pour le remplacement de la prise femelle obsolète.

Warnung! Der Sicherheitszweck des gepolten bzw. Schukosteckers ist zu berücksichtigen. Ein gepolter Stecker verfügt über zwei Pole, von denen einer breiter als der andere ist. Ein Schukostecker verfügt neben den zwei Polen noch über einen dritten Pol zur Erdung. Der breite Pol bzw. der Erdungspol dienen der Sicherheit. Wenn der zur Verfügung gestellte Stecker nicht in Ihren Anschluss passt, konsultieren Sie einen Elektriker, um den veralteten Anschluss zu ersetzen.

¡Advertencia! No eche por tierra la finalidad del tipo de enchufe polarizado con conexión a tierra. Un enchufe polarizado tiene dos espigas, una más ancha que la otra. Un enchufe con conexión a tierra tiene dos espigas iguales y una tercera espiga que sirve para la conexión a tierra. La espiga ancha, o la tercera espiga, sirven para su seguridad. Si el enchufe suministrado no encaja en el tomacorriente, consulte con un electricista para reemplazar el tomacorriente obsoleto.

Aviso! Não anule a finalidade da segurança da ficha polarizada ou do tipo ligação terra. Uma ficha polarizada tem duas lâminas sendo uma mais larga do que a outra. Uma ficha do tipo de ligação à terra tem duas lâminas e um terceiro terminal de ligação à terra. A lâmina larga ou o terceiro terminal são fornecidos para sua segurança. Se a ficha fornecida não couber na sua tomada, consulte um electricista para a substituição da tomada obsoleta.

Avviso! Non compromettere la sicurezza della spina polarizzata o con messa a terra. Una spina polarizzata ha due spinotti, di cui uno più largo. Una spina con messa a terra ha due spinotti e un terzo polo per la messa a terra. Lo spinotto largo o il terzo polo sono forniti per motivi di sicurezza. Se la spina fornita non si inserisce nella presa di corrente, contattare un elettricista per la sostituzione della presa obsoleta.



Warning! Since the Mains plug is used as the disconnection for the device, it must remain readily accessible and operable.

Avertissement! Puisque la prise principale est utilisée pour débrancher l'appareil, elle doit rester aisément accessible et fonctionnelle.

Warnung! Da der Netzstecker als Trennvorrichtung dient, muss er stets zugänglich und funktionsfähig sein.

¡Advertencia! Puesto que el enchufe de la red eléctrica se utiliza como dispositivo de desconexión, debe seguir siendo fácilmente accesible y operable.

Aviso! Dado que a ficha principal é utilizada como a desconexão para o dispositivo, esta deve manter-se prontamente acessível e funcional.

Avviso! Poiché il cavo di alimentazione viene usato come dispositivo di sconnessione, deve rimanere prontamente accessibile e operabile.



Warning! Protect the power cord from being walked on or pinched particularly at plugs, convenience receptacles, and the point where they exit from the device.

Avertissement! Protégez le cordon d'alimentation pour que l'on ne marche pas dessus ou qu'on le pince, en particulier au niveau des prises mâles, des réceptacles de convenance, et à l'endroit où il sort de l'appareil.

Warnung! Vermeiden Sie, dass auf das Netzkabel getreten oder das Kabel geknickt wird, insbesondere an den Steckern, den Steckdosen und am Kabelausgang am Gerät.

¡Advertencia! Proteja el cable de corriente para que no se le pise ni apriete, en especial cerca del enchufe, los receptáculos de conveniencia y el punto del que salen del equipo.

Aviso! Proteja o cabo de alimentação de ser pisado ou de ser comprimido particularmente nas fichas, em tomadas de parede de conveniência e no ponto de onde sai do dispositivo.

Avviso! Proteggere il cavo di alimentazione in modo che nessuno ci cammini sopra e che non venga schiacciato soprattutto in corrispondenza delle spine e del punto in cui esce dal dispositivo.



Warning! Unplug this device during lightning storms or when unused for long periods of time.

Avertissement! Débranchez cet appareil pendant les orages avec éclairsou s'il est inutilisé pendant de longues périodes.

Warnung! Das Gerät ist bei Gewitterstürmen oder wenn es über lange Zeiträume ungenutzt bleibt vom Netz zu trennen.

¡Advertencia! Desenchufe este dispositivo durante tormentas eléctricas o cuando no se lo utilice por largos periodos del tiempo.

Aviso! Desconecte este dispositivo da tomada durante trovoadas ou quando não é utilizado durante longos períodos de tempo.

Avviso! Utilizzare soltanto i collegamenti e gli accessori specificati e/o venduti dal produttore, quali il treppiedi e l'esoscheletro.



Warning! Refer all servicing to qualified service personnel. Servicing is required when the device has been damaged in any way, such as power-supply cord or plug is damaged, liquid has been spilled or objects have fallen into the device, the device has been exposed to rain or moisture, does not operate normally, or has been dropped.

Avertissement! Référez-vous au personnel de service qualifié pour tout entretien. L'entretien est exigé quand l'appareil a été endommagé de quelque manière que ce soit, par exemple lorsque le cordon d'alimentation ou la prise sont endommagés, que du liquide a été versé ou des objets sont tombés dans l'appareil, que l'appareil a été exposé à la pluie ou à l'humidité, ne fonctionne pas normalement ou est tombé.

Warnung! Das Gerät sollte nur von qualifizierten Fachkräften gewartet werden. Eine Wartung ist fällig, wenn das Gerät in irgendeiner Weise beschädigt wurde, wie bei beschädigtem Netzkabel oder Netzstecker, falls Flüssigkeiten oder Objekte in das Gerät gelangen, das Gerät Regen oder Feuchtigkeit ausgesetzt wurde, nicht ordnungsgemäß funktioniert oder fallen gelassen wurde.

¡Advertencia! Consulte al personal calificado por cuestiones de reparación. El servicio de reparación se requiere cuando el dispositivo ha recibido cualquier tipo de daño, por ejemplo cable o espigas dañadas, se ha derramado líquido o se han caído objetos dentro del dispositivo, el dispositivo ha sido expuesto a la lluvia o humedad, o no funciona de modo normal, o se ha caído.

Aviso! Remeta todos os serviços de manutenção para o pessoal de assistência qualificado. A prestação de serviços de manutenção é exigida quando o dispositivo foi danificado mediante qualquer forma, como um cabo de alimentação ou ficha que se encontra danificado/a, quando foi derramado líquido ou caíram objectos sobre o dispositivo, quando o dispositivo foi exposto à chuva ou à humidade, quando não funciona normalmente ou quando foi deixado cair.

Avviso! Fare riferimento al personale qualificato per tutti gli interventi di assistenza. L'assistenza è necessaria quando il dispositivo è stato danneggiato in qualche modo, ad esempio se il cavo di alimentazione o la spina sono danneggiati, è stato rovesciato del liquido è stato rovesciato o qualche oggetto è caduto nel dispositivo, il dispositivo è stato esposto a pioggia o umidità, non funziona correttamente o è caduto.



Warning! Do not open the chassis. There are no user-serviceable parts inside. Opening the chassis will void the warranty unless performed by an AJA service center or licensed facility.

Avertissement! Ne pas ouvrir le châssis. Aucun élément à l'intérieur du châssis ne peut être réparé par l'utilisateur. La garantie sera annulée si le châssis est ouvert par toute autre personne qu'un technicien d'un centre de service ou d'un établissement agréé AJA.

Warnung! Öffnen Sie das Gehäuse nicht. Keine der Geräteteile können vom Benutzer gewartet werden. Durch das Öffnen des Gehäuses wird die Garantie hinfällig, es sei denn, solche Wartungsarbeiten werden in einem AJA-Service-Center oder einem lizenzierten Betrieb vorgenommen.

¡Advertencia! No abra el chasis. El interior no contiene piezas reparables por el usuario. El abrir el chasis anulará la garantía a menos que se lo haga en un centro de servicio AJA o en un local autorizado.

Advertência! Não abra o chassi. Não há internamente nenhuma peça que permita manutenção pelo usuário. Abrir o chassi anula a garantia, a menos que a abertura seja realizada por uma central de serviços da AJA ou por um local autorizado.

Avvertenza! Non aprire lo chassis. All'interno non ci sono parti riparabili dall'utente. L'apertura dello chassis invaliderà la garanzia se non viene effettuata da un centro ufficiale o autorizzato AJA.



Warning! Disconnect the external AC power supply line cord(s) from the mains power before moving the unit.

Avertissement! Retirez le ou les cordons d'alimentation en CA de la source d'alimentation principale lorsque vous déplacez l'appareil.

Warnung! Trennen Sie die Wechselstrom-Versorgungskabel vom Netzstrom, bevor Sie das Gerät verschieben.

¡Advertencia! Cuando mueva la unidad desenchufe de la red eléctrica el/los cable(s) de la fuente de alimentación CA tipo brick.

Advertência! Remova os cabos CA de alimentação brick da rede elétrica ao mover a unidade.

Avvertenza! Scollegare il cavo dell'alimentatore quando si sposta l'unità.



Warning! Only use attachments and accessories specified and/or sold by the manufacturer.

Avertissement! Utilisez seulement les attaches et accessoires spécifiés et/ou vendus par le fabricant.

Warnung! Verwenden Sie nur Zusatzgeräte und Zubehör angegeben und / oder verkauft wurde durch den Hersteller.

¡Advertencia! Utilice solamente los accesorios y conexiones especificados y/o vendidos por el fabricante.

Aviso! Utilize apenas equipamentos/acessórios especificados e/ou vendidos pelo fabricante.

Avviso! Utilizzare soltanto i collegamenti e gli accessori specificati e/o venduti dal produttore.



Hazard! High Voltage. This situation or condition can cause injury due to electric shock.

Avertissement! Tension élevée. Cette situation ou condition peut causer des blessures dues à un choc électrique.

Warnung! Hochspannung. Diese Situation oder Bedingung kann zu Verletzungen durch Stromschlag führen.

¡Advertencia! Alto voltaje. Esta situación o condición puede causar lesiones debidas a una descarga eléctrica.

Aviso! Alta Tensão. Esta situação ou condição pode causar danos devido a choques elétricos.

Avviso! Alta tensione. Questa situazione o condizione può causare lesioni a causa di scosse elettriche.



Caution! To meet safety regulations for leakage current, connect the dual power supplies to separate branch circuits.

¡Advertencia! Para cumplir con las normas de seguridad para la corriente de fuga, conecte las dos fuentes de alimentación para circuitos derivados diferentes.

Attention! Pour répondre aux mesures de sécurité concernant le courant de fuite, raccorder les sources d'alimentation doubles à des circuits de dérivation distincts.

Warnung! Zur Erfüllung der Sicherheitsbestimmungen bezüglich Reststrom schließen Sie bitte die zwei Netzteile an unterschiedlichen Abzweigleitungen an.

Cuidado! Para atender aos regulamentos de segurança para correntes de fuga, conecte as fontes duplas a circuitos elétricos separados.

Attenzione! Per soddisfare le norme di sicurezza sulla corrente di perdita, collegare i doppi alimentatori a circuiti derivati separati.



Warning! Ensure Mains Power is disconnected before installing the OG-C10DA modules into the frame, or installing and removing options. If a Mains switch is not provided, the power cord(s) of this equipment provide the means of disconnection. The socket outlet must be installed near the equipment and must be easily accessible.

Avertissement ! Avant d'installer des modules OG-C10DA dans la structure, ainsi qu'avant d'installer ou d'enlever des options, assurez-vous d'avoir déconnecté l'alimentation électrique. S'il n'y a pas d'interrupteur électrique, il faut débrancher les câbles électriques de l'équipement. La prise électrique doit être située à proximité de l'équipement et doit être aisément accessible.

Achtung! Sicherstellen, dass die Netzleitung entkoppelt ist, bevor die OG-C10DA Module in das Gestell eingebaut oder Wahlteile eingebaut bzw. ausgebaut werden. Wenn kein Netzschalter vorgesehen ist, dient das bzw. dienen die Netzkabel dieser Vorrichtung als Entkopplungsmittel. Die Steckdose muss in der Nähe der Vorrichtung installiert und leicht zugänglich sein.

Avvertenza. Accertarsi che l'alimentazione di rete sia scollegata prima di installare i moduli OG-C10DA nel frame o di installare e rimuovere componenti opzionali. Se non è presente un interruttore di accensione/spengimento, occorre scollegare il cavo (o i cavi) di alimentazione di questo apparecchio dalla presa di corrente. La presa di corrente deve essere situata presso l'apparecchio e facilmente accessibile.

Aviso! Certifique-se que a fonte principal de energia elétrica está desconectada antes de instalar os módulos OG-C10DA no bastidor ou antes de instalar e remover opções. Se o interruptor principal não existir, o cabo elétrico deste equipamento proporciona o meio de desconexão. A tomada elétrica deverá ser instalada perto do equipamento e deverá ser de fácil acesso.

¡Advertencia! Asegúrese que la red de alimentación está desconectada antes de instalar los módulos OG-C10DA en el marco, o la instalación y extracción de opciones. Si no se proporciona un conmutador de red, el cable de alimentación de este equipo proporciona los medios de desconexión. El zócalo tomacorriente debe estar instalado cerca del equipo y debe ser fácilmente accesible.



Warning! Dual Power Cord Notice—please read this. To reduce the risk of electrical shock, disconnect both power cords before servicing equipment.

Avertissement ! Avis concernant la double alimentation électrique—à lire soigneusement. Pour éviter tout risque d'électrocution, débranchez les deux câbles électriques avant d'intervenir sur l'équipement.

Achtung! Hinweis auf Doppel-Netzkabel-bitte lesen. Um das Risiko eines Elektroschocks zu verringern, müssen beide Netzkabel ausgestöpselt werden, bevor die Vorrichtung gewartet wird.

Avvertenza. Avviso concernente il cavo di alimentazione doppio - leggere attentamente. Per ridurre il rischio di elettrocuzione, scollegare entrambi i cavi di alimentazione prima di eseguire la manutenzione o riparazioni di questo apparecchio.

Aviso! Aviso de Cabo Elétrico Duplo - por favor, leia isto. Para reduzir o risco de choque elétrico, desconecte ambos os cabos elétricos antes de fazer manutenção ao equipamento.

¡Advertencia! Aviso del doble cable de alimentación - leer esto por favor. Para reducir el riesgo de descarga eléctrica, desconecte ambos cables de alimentación antes de dar servicio al equipo.



Caution! The OG-X-FR front fan door is heavy. Remove with Caution.

Attention! La porte du ventilateur avant OG-X-FR est lourde. Retirer avec précaution.

Achtung! Die OG-X-FR Frontlüfter Tür ist schwer. Bitte vorsichtig entfernen.

¡Precaución! La puerta del ventilador frontal OG-X-FR es pesado. Extraer con precaución.

Atenção! A porta do ventilador frontal OG-X-FR é pesado. Remova com cuidado.

Attenzione! La porta ventola anteriore OG-X-FR è pesante. Rimuovere con cautela.

5 Year Warranty and Liability Information

Limited Warranty on Hardware

AJA Video Systems, Inc. (AJA Video) warrants that the hardware product, not including software components, will be free from defects in materials and workmanship for a period of five years from the date of purchase. AJA Video provides a separate software warranty as part of the license agreement applicable to software components.

If the Customer brings a valid claim under this limited warranty for a hardware product (hereafter, a “product”) during the applicable warranty period, AJA Video will, at its sole option and as the Customer’s sole remedy for breach of the above warranty, provide one of the following remedies:

- Repair or facilitate the repair the product within a reasonable period of time, free of charge for parts and labor.
- Replace the product with a direct replacement or with a product that performs substantially the same function as the original product.
- Issue a refund of the original purchase price less depreciation to be determined based on the age of the product at the time remedy is sought under this limited warranty.

To obtain service under this warranty, the Customer must notify AJA Video of the defect before expiration of the warranty period and make suitable arrangements for the performance of service by contacting AJA Video support through the channels set forth on the support contacts web page at <https://www.aja.com/support>.

Except as stated, the Customer shall bear all shipping, packing, insurance and other costs, excluding parts and labor, to effectuate repair. Customer shall pack and ship the defective product to a service center designated by AJA Video, with shipping charges prepaid. AJA Video shall pay to return the product to Customer, but only if to a location within the country in which the AJA Video service center is located. SOME JURISDICTIONS DO NOT ALLOW THE EXCLUSION OF IMPLIED WARRANTIES OR LIMITATIONS ON APPLICABLE STATUTORY RIGHTS OF A CONSUMER, SO SOME OR ALL OF THE TERMS OF THIS PARAGRAPH MAY NOT APPLY TO YOU.

Limitation of Liability

Under no circumstances shall AJA video BE LIABLE IN ANY WAY FOR ANY LOST, CORRUPTED OR DESTROYED DATA, FOOTAGE OR WORK, OR FOR ANY OTHER INDIRECT, SPECIAL, INCIDENTAL OR CONSEQUENTIAL DAMAGES OR LOST PROFITS, OR FOR ANY THIRD PARTY CLAIM, IN CONNECTION WITH THE PRODUCT, WHETHER RESULTING FROM DEFECTS IN THE PRODUCT, SOFTWARE OR HARDWARE FAILURE, OR ANY OTHER CAUSE WHATSOEVER, EVEN IF AJA VIDEO HAS BEEN ADVISED OF THE POSSIBILITY OF SUCH DAMAGES. AJA VIDEO’S LIABILITY IN CONNECTION WITH THE PRODUCT SHALL UNDER NO CIRCUMSTANCES EXCEED THE PURCHASE PRICE PAID FOR THE PRODUCT. The foregoing limitations apply even if any remedy set forth in this LIMITED WARRANTY fails of its essential purpose. SOME JURISDICTIONS DO NOT ALLOW THE LIMITATION OF LIABILITY FOR PERSONAL INJURY, OR OF INCIDENTAL OR CONSEQUENTIAL DAMAGES, SO SOME OR ALL OF THE TERMS OF THIS PARAGRAPH MAY NOT APPLY TO YOU.

Governing Law and Language; Your Rights

This limited warranty is the only warranty provided by AJA Video on the hardware product. It supersedes all prior or contemporaneous understandings regarding such subject matter. No amendment to or modification of this warranty will be binding unless in writing and signed by AJA Video. The laws of the State of California, USA will govern this warranty and any dispute arising from it. Any translation of this Agreement is intended for convenience and to meet local requirements and in the event of a dispute between the English and any non-English versions, the English version of this warranty will govern. This limited warranty gives you specific legal rights and you may have other rights that vary from jurisdiction to jurisdiction, some of which are noted above.

AJA Software License Agreement

AJA VIDEO SYSTEMS, INC.

THIS IS AN AGREEMENT BETWEEN YOU AND AJA VIDEO SYSTEMS, INC. ("AJA") THAT GOVERNS YOUR USE OF THE SOFTWARE ACCOMPANYING THIS LICENSE (E.G., AS INSTALLED ON THE DEVICE WITH WHICH THIS LICENSE IS PROVIDED).

The "AJA Software" referenced in this Agreement includes all such software, whether made available to you on disk, in read only memory, on any other media or in any other form, and all updates, corrections, enhancements and new versions of such software made available by AJA, together with all related documentation. BY INSTALLING OR USING THE AJA SOFTWARE, YOU ARE AGREEING TO BE BOUND BY THE TERMS OF THIS AGREEMENT. IF YOU DO NOT AGREE TO THE TERMS OF THIS AGREEMENT, DO NOT INSTALL OR USE IT AND, IF APPLICABLE, RETURN THE AJA SOFTWARE TO THE PLACE WHERE YOU OBTAINED IT FOR A REFUND.

1. License Grant. AJA hereby grants you a nonexclusive, personal, non-sublicenseable and limited license to install and use AJA Software on a computer or AJA device. The foregoing license also includes the right to make copies of the AJA Software in machine-readable form for installation and backup purposes only, and provided that each copy you make must include all copyright or other proprietary notices contained on the original.

2. Limitations. You may not decompile, reverse engineer, disassemble, modify, or create derivative works of the AJA Software or any part thereof except to the extent (if any) authorized by applicable law notwithstanding the foregoing restriction. You may not rent, lease, lend, loan, distribute or act as a service bureau or "cloud service" provider with respect to use of the AJA Software or any functionality thereof. THE AJA SOFTWARE IS NOT INTENDED FOR USE IN THE OPERATION OF NUCLEAR FACILITIES, AIRCRAFT NAVIGATION OR COMMUNICATION SYSTEMS, AIR TRAFFIC CONTROL SYSTEMS, LIFE SUPPORT MACHINES OR OTHER EQUIPMENT IN WHICH THE FAILURE OF THE AJA SOFTWARE COULD LEAD TO DEATH, PERSONAL INJURY, OR SEVERE PHYSICAL OR ENVIRONMENTAL DAMAGE.

3. Reservation of Rights. The AJA Software is protected by law, including without limitation copyright law. The AJA Software is licensed, not sold, to you. AJA and its licensors reserve all rights not expressly granted to you by this Agreement. You own the media on which the AJA Software is recorded but AJA and/or AJA's licensor(s) retain ownership of the AJA Software itself. You may not use the AJA Software for any illegal purpose.

4. Transfer. You may make a one-time permanent transfer of all of your license rights to the AJA Software to another person or entity, provided that: (a) you transfer all of the AJA Software, including all its component parts, original media, printed materials and this Agreement; (b) you do not retain any copies of the AJA Software, including any copies stored on a computer or other device; and (c) you transfer the AJA Software subject to this Agreement, and the person or entity receiving the AJA Software accepts the terms and conditions of this Agreement.

5. NFR (Not for Resale) Copies and Add-On Features: Notwithstanding anything to the contrary in this Agreement, (a) AJA Software that is labeled "Not for Resale" or otherwise provided to you on a promotional or demonstration basis may be used only for your demonstration, testing and evaluation purposes and may not be resold or transferred; and (b) AJA may make available certain software components ("Add-On Features") under separate terms and conditions, in which case those separate terms and conditions apply and the Add-On Features are not considered AJA Software under this Agreement.

6. Termination. Your rights in the AJA Software are conditioned on complying with this Agreement, and those rights (together with this Agreement) will terminate automatically, without notice from AJA, if you fail to comply with any term(s) of this Agreement. Upon termination of this Agreement, you must cease all use of the AJA Software and destroy all copies, full or partial, of the AJA Software in your possession or control.

7. Limited Warranty on AJA Software. If you comply with all terms of this Agreement and use the AJA Software in accordance with its documentation, and you install any patches or other updates made available to the AJA Software by AJA, AJA warrants that the AJA Software will perform substantially in accordance with its documentation for a period of ninety (90) days from the date of your original retail purchase. Your exclusive remedy under this warranty will be, at AJA's option, a refund of the purchase

price of the product containing the AJA Software or an update to or replacement of the AJA Software (or applicable component of it). THIS LIMITED WARRANTY AND ANY IMPLIED WARRANTIES ON THE AJA SOFTWARE INCLUDING, BUT NOT LIMITED TO, ANY WARRANTIES OF MERCHANTABILITY, OF SATISFACTORY QUALITY, OR OF FITNESS FOR A PARTICULAR PURPOSE, ARE LIMITED IN DURATION TO NINETY (90) DAYS FROM THE DATE OF ORIGINAL RETAIL PURCHASE. SOME JURISDICTIONS DO NOT ALLOW LIMITATIONS ON HOW LONG A WARRANTY LASTS, SO THE ABOVE LIMITATION MAY NOT APPLY TO YOU. THIS LIMITED WARRANTY GIVES YOU SPECIFIC LEGAL RIGHTS, AND YOU MAY ALSO HAVE OTHER RIGHTS WHICH VARY BY JURISDICTION.

8. Disclaimer of Other Warranties on AJA Software. EXCEPT FOR THE LIMITED WARRANTY ON AJA SOFTWARE SET FORTH ABOVE, AJA AND AJA'S LICENSORS (COLLECTIVELY REFERRED TO AS "AJA" FOR THE PURPOSES OF SECTIONS 8 AND 9) HEREBY DISCLAIM ALL WARRANTIES AND CONDITIONS WITH RESPECT TO THE AJA SOFTWARE, WHETHER EXPRESS, IMPLIED OR STATUTORY, INCLUDING, BUT NOT LIMITED TO, THE IMPLIED WARRANTIES AND/OR CONDITIONS OF MERCHANTABILITY, OF SATISFACTORY QUALITY, OF FITNESS FOR A PARTICULAR PURPOSE, OF ACCURACY, AND OF QUIET ENJOYMENT. FURTHER, AJA DOES NOT MAKE ANY WARRANTY REGARDING NON-INFRINGEMENT OF THIRD PARTY RIGHTS. SUBJECT ONLY TO THE LIMITED WARRANTY SET FORTH IN SECTION 7, YOU EXPRESSLY ACKNOWLEDGE AND AGREE THAT USE OF THE AJA SOFTWARE IS AT YOUR SOLE RISK. AJA DOES NOT WARRANT AGAINST INTERFERENCE WITH YOUR ENJOYMENT OF THE AJA SOFTWARE, THAT THE AJA SOFTWARE WILL MEET YOUR REQUIREMENTS, THAT THE OPERATION OF THE AJA SOFTWARE WILL BE UNINTERRUPTED OR ERROR-FREE, OR THAT DEFECTS IN THE AJA SOFTWARE WILL BE CORRECTED. NO ORAL OR WRITTEN INFORMATION OR ADVICE GIVEN BY AJA OR AN AJA AUTHORIZED REPRESENTATIVE WILL CREATE A WARRANTY. SOME JURISDICTIONS DO NOT ALLOW THE EXCLUSION OF IMPLIED WARRANTIES OR LIMITATIONS ON APPLICABLE STATUTORY RIGHTS OF A CONSUMER, SO SOME OR ALL OF THE TERMS OF THIS PARAGRAPH MAY NOT APPLY TO YOU.

9. Limitation of Liability. TO THE EXTENT NOT PROHIBITED BY LAW, IN NO EVENT WILL AJA BE LIABLE FOR PERSONAL INJURY, OR ANY INCIDENTAL, SPECIAL, INDIRECT OR CONSEQUENTIAL DAMAGES OR LOST PROFITS WHATSOEVER, INCLUDING, WITHOUT LIMITATION, DAMAGES FOR LOSS OF DATA, BUSINESS INTERRUPTION OR ANY OTHER COMMERCIAL DAMAGES OR LOSSES, ARISING OUT OF OR RELATED TO YOUR USE OR INABILITY TO USE THE AJA SOFTWARE, HOWEVER CAUSED, REGARDLESS OF THE THEORY OF LIABILITY (E.G., WHETHER UNDER CONTRACT, TORT OR OTHERWISE) AND EVEN IF AJA HAS BEEN ADVISED OF THE POSSIBILITY OF SUCH DAMAGES. IN NO EVENT WILL AJA'S TOTAL LIABILITY TO YOU FOR ALL DAMAGES (INCLUDING WITHOUT LIMITATION BREACH OF WARRANTY) EXCEED THE AMOUNT OF FIFTY DOLLARS (\$50.00). THE FOREGOING LIMITATIONS WILL APPLY EVEN IF THE ANY REMEDY SET FORTH IN THIS AGREEMENT FAILS OF ITS ESSENTIAL PURPOSE. SOME JURISDICTIONS DO NOT ALLOW THE LIMITATION OF LIABILITY FOR PERSONAL INJURY, OR OF INCIDENTAL OR CONSEQUENTIAL DAMAGES, SO SOME OR ALL OF THE TERMS OF THIS PARAGRAPH MAY NOT APPLY TO YOU.

10. Export Law Assurances. You may not use or otherwise export or reexport the AJA Software except as authorized by United States law and the laws of the jurisdiction in which the AJA Software was obtained. In particular, but without limitation, the AJA Software may not be exported or re-exported (a) into (or to a national or resident of) any U.S. embargoed countries, or (b) to anyone on the U.S. Treasury Department's list of Specially Designated Nationals or the U.S. Department of Commerce Denied Persons List or Entity List or any similar legal designation. By using the AJA Software, you represent and warrant that you are not located in, under control of, or a national or resident of any such country or on any such list.

11. Government End Users. The AJA Software including its documentation is a "Commercial Item", as that term is defined at 48 C.F.R. § 2.101, consisting of "Commercial Computer Software" and "Commercial Computer Software Documentation", as such terms are used in 48 C.F.R. § 12.212 or 48 C.F.R. § 227.7202 (or their successors), as applicable. Consistent with these provisions, the AJA Software is licensed to U.S. Government end users (a) only as a Commercial Item and (b) with only those rights as are granted to all other end users pursuant to this Agreement. Unpublished-rights reserved under the copyright laws of the United States.

12. Controlling Law and Severability. This Agreement will be governed by and construed in accordance with the laws of the State of California, as applied to agreements entered into and to be performed entirely within California between California residents. This Agreement will not be governed by the United Nations

Convention on Contracts for the International Sale of Goods, the application of which is expressly excluded. If for any reason a court of competent jurisdiction finds any provision, or portion thereof, to be unenforceable, the remainder of this Agreement will continue in full force and effect.

13. Complete Agreement; Governing Language. This Agreement constitutes the entire agreement between the parties with respect to the use of the AJA Software licensed hereunder and supersedes all prior or contemporaneous understandings regarding such subject matter. No amendment to or modification of this Agreement will be binding unless in writing and signed by AJA. Any translation of this Agreement is intended for convenience and to meet local requirements and in the event of a dispute between the English and any non-English versions, the English version of this Agreement will govern.

Index

A

- AJA Software License Agreement 34
- AJA's openGear 4
- AJA Support 2

C

- Card Name 15

D

- DashBoard Control System 8
 - Card Tab Screen 15
 - Documentation 13
 - Downloading 13
 - Rebooting 20
 - Requirements 13
 - Setup Tab Screen 18
 - Status Tab Screen 16
 - Uploading New Software 18
 - Using 12
- Diagram
 - Simplified Block 5
- DIP Switches 5, 12
 - Description of Settings 12

F

- Features 4

I

- Installation 8
 - Cabling 11
- I/O Connections 5

J

- Jitter 17

O

- openGear and AJA 8
- Overview 4

P

- Preprocess 17

S

- Signal Indicators
 - DashBoard Control System 6

U

- User Controls 8